

Phase leg MOSFET Power Module

$V_{DSS} = 1200V$
 $R_{DSon} = 150m\Omega \text{ typ @ } T_j = 25^\circ C$
 $I_D = 60A \text{ @ } T_c = 25^\circ C$

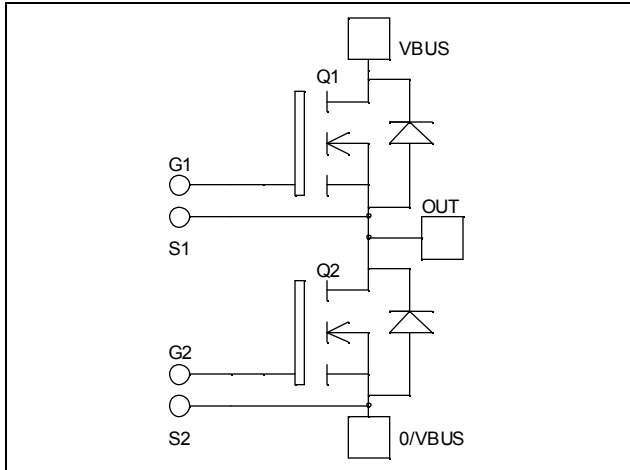

Application

- Welding converters
- Switched Mode Power Supplies
- Uninterruptible Power Supplies
- Motor control

Features

- Power MOS 7[®] FREDFETs
 - Low R_{DSon}
 - Low input and Miller capacitance
 - Low gate charge
 - Fast intrinsic reverse diode
 - Avalanche energy rated
 - Very rugged
- Kelvin source for easy drive
- Very low stray inductance
 - Symmetrical design
 - M5 power connectors
- High level of integration

Benefits

- Outstanding performance at high frequency operation
- Direct mounting to heatsink (isolated package)
- Low junction to case thermal resistance
- Low profile
- RoHS Compliant

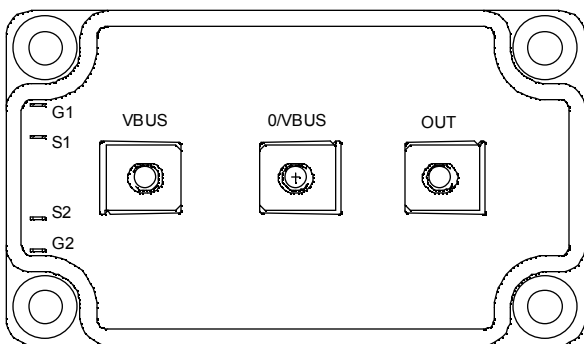

Absolute maximum ratings

| Symbol | Parameter | Max ratings | Unit |
|------------|---|--------------------|------------|
| V_{DSS} | Drain - Source Breakdown Voltage | 1200 | V |
| I_D | Continuous Drain Current | $T_c = 25^\circ C$ | 60 |
| | | $T_c = 80^\circ C$ | 45 |
| I_{DM} | Pulsed Drain current | 240 | A |
| V_{GS} | Gate - Source Voltage | ± 30 | V |
| R_{DSon} | Drain - Source ON Resistance | 175 | m Ω |
| P_D | Maximum Power Dissipation | $T_c = 25^\circ C$ | 1250 |
| I_{AR} | Avalanche current (repetitive and non repetitive) | 22 | A |
| E_{AR} | Repetitive Avalanche Energy | 50 | mJ |
| E_{AS} | Single Pulse Avalanche Energy | 3000 | |

CAUTION: These Devices are sensitive to Electrostatic Discharge. Proper Handling Procedures Should Be Followed. See application note APT0502 on www.microsemi.com

All ratings @ $T_j = 25^\circ\text{C}$ unless otherwise specified

Electrical Characteristics

| Symbol | Characteristic | Test Conditions | Min | Typ | Max | Unit |
|--------------|---------------------------------|---|---------------------------|-----|-----------|------------------|
| I_{DSS} | Zero Gate Voltage Drain Current | $V_{GS} = 0\text{V}, V_{DS} = 1200\text{V}$ | | | 500 | μA |
| | | $V_{GS} = 0\text{V}, V_{DS} = 1000\text{V}$ | $T_j = 125^\circ\text{C}$ | | 3000 | |
| $R_{DS(on)}$ | Drain – Source on Resistance | $V_{GS} = 10\text{V}, I_D = 30\text{A}$ | | 150 | 175 | $\text{m}\Omega$ |
| $V_{GS(th)}$ | Gate Threshold Voltage | $V_{GS} = V_{DS}, I_D = 10\text{mA}$ | 3 | | 5 | V |
| I_{GSS} | Gate – Source Leakage Current | $V_{GS} = \pm 30\text{V}, V_{DS} = 0\text{V}$ | | | ± 250 | nA |

Dynamic Characteristics

| Symbol | Characteristic | Test Conditions | Min | Typ | Max | Unit |
|--------------|------------------------------|---|-----|------|-----|------|
| C_{iss} | Input Capacitance | $V_{GS} = 0\text{V}$ | | 20.6 | | nF |
| C_{oss} | Output Capacitance | $V_{DS} = 25\text{V}$ | | 3.08 | | |
| C_{rss} | Reverse Transfer Capacitance | $f = 1\text{MHz}$ | | 0.52 | | |
| Q_g | Total gate Charge | $V_{GS} = 10\text{V}$ | | 748 | | nC |
| Q_{gs} | Gate – Source Charge | $V_{Bus} = 600\text{V}$ | | 96 | | |
| Q_{gd} | Gate – Drain Charge | $I_D = 60\text{A}$ | | 480 | | |
| $T_{d(on)}$ | Turn-on Delay Time | Inductive switching @ 125°C | | 20 | | ns |
| T_r | Rise Time | $V_{GS} = 15\text{V}$ | | 15 | | |
| $T_{d(off)}$ | Turn-off Delay Time | $V_{Bus} = 800\text{V}$ | | 160 | | |
| T_f | Fall Time | $I_D = 60\text{A}$ $R_G = 1.2\Omega$ | | 45 | | |
| E_{on} | Turn-on Switching Energy | Inductive switching @ 25°C | | 3.96 | | mJ |
| E_{off} | Turn-off Switching Energy | $V_{GS} = 15\text{V}, V_{Bus} = 800\text{V}$ $I_D = 60\text{A}, R_G = 1.2\Omega$ | | 2.74 | | |
| E_{on} | Turn-on Switching Energy | Inductive switching @ 125°C | | 6.26 | | mJ |
| E_{off} | Turn-off Switching Energy | $V_{GS} = 15\text{V}, V_{Bus} = 800\text{V}$ $I_D = 60\text{A}, R_G = 1.2\Omega$ | | 3.43 | | |

Source - Drain diode ratings and characteristics

| Symbol | Characteristic | Test Conditions | Min | Typ | Max | Unit | |
|----------|---|---|---------------------------|-----|-----|---------------|----|
| I_S | Continuous Source current (Body diode) | $T_c = 25^\circ\text{C}$ | | | 60 | A | |
| | | $T_c = 80^\circ\text{C}$ | | | 45 | | |
| V_{SD} | Diode Forward Voltage | $V_{GS} = 0\text{V}, I_S = -60\text{A}$ | | | 1.3 | V | |
| dv/dt | Peak Diode Recovery ① | | | | 18 | V/ns | |
| t_{rr} | Reverse Recovery Time | $I_S = -60\text{A}$ $V_R = 600\text{V}$ $di/dt = 400\text{A}/\mu\text{s}$ | $T_j = 25^\circ\text{C}$ | | | 320 | ns |
| | | | $T_j = 125^\circ\text{C}$ | | | 650 | |
| Q_{rr} | Reverse Recovery Charge | $I_S = -60\text{A}$ $V_R = 600\text{V}$ $di/dt = 400\text{A}/\mu\text{s}$ | $T_j = 25^\circ\text{C}$ | | 8 | μC | |
| | | | $T_j = 125^\circ\text{C}$ | | 28 | | |

 ① dv/dt numbers reflect the limitations of the circuit rather than the device itself.

$$I_S \leq -60\text{A} \quad di/dt \leq 700\text{A}/\mu\text{s} \quad V_R \leq V_{DSS} \quad T_j \leq 150^\circ\text{C}$$

Thermal and package characteristics

Symbol Characteristic

| | | <i>Min</i> | <i>Typ</i> | <i>Max</i> | <i>Unit</i> | |
|------------|--|---------------|------------|------------|-------------|-----|
| R_{thJC} | Junction to Case Thermal Resistance | | | 0.1 | °C/W | |
| V_{ISOL} | RMS Isolation Voltage, any terminal to case t = 1 min, I isol < 1mA, 50/60Hz | 2500 | | | V | |
| T_J | Operating junction temperature range | -40 | | 150 | °C | |
| T_{STG} | Storage Temperature Range | -40 | | 125 | | |
| T_C | Operating Case Temperature | -40 | | 100 | | |
| Torque | Mounting torque | To heatsink | M6 | 3 | 5 | N.m |
| | | For terminals | M5 | 2 | 3.5 | |
| Wt | Package Weight | | | 280 | g | |

SP6 Package outline (dimensions in mm)

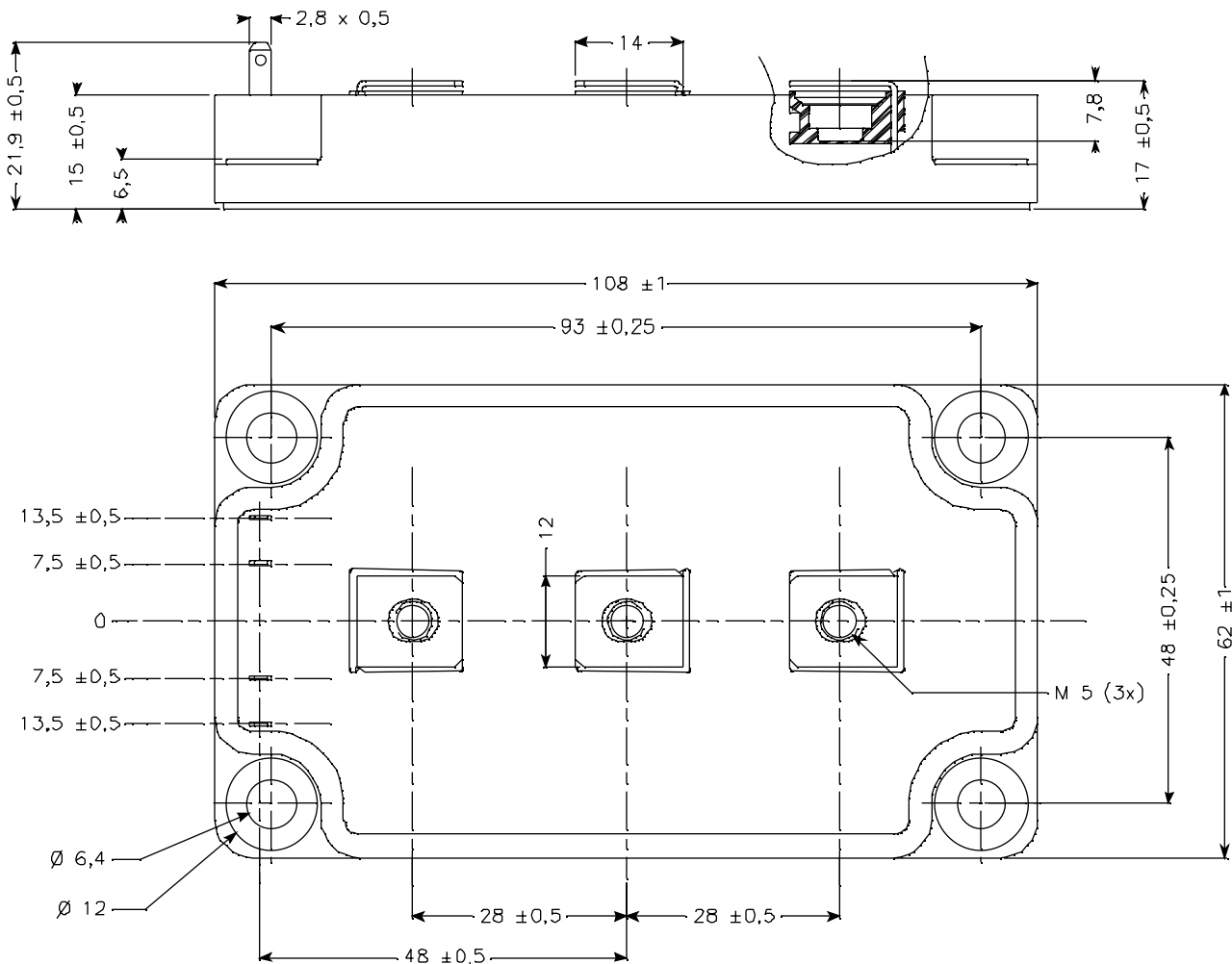

See application note APT0601 - Mounting Instructions for SP6 Power Modules on www.microsemi.com

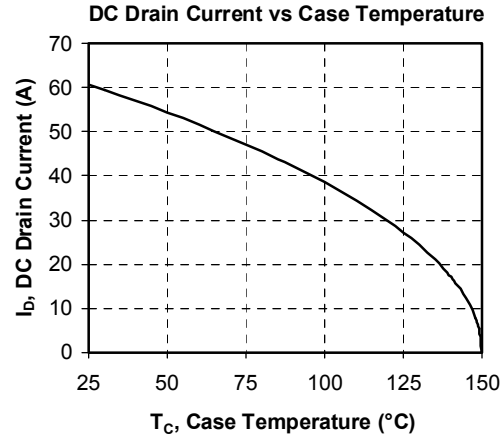
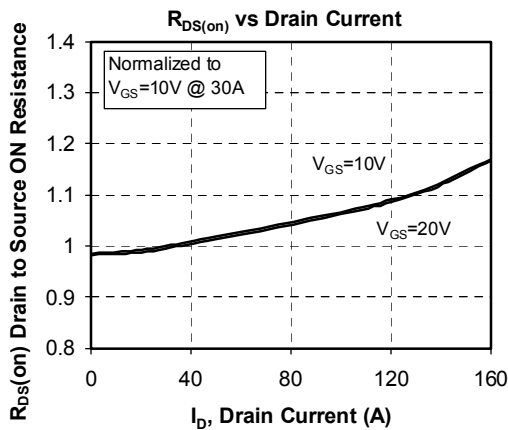
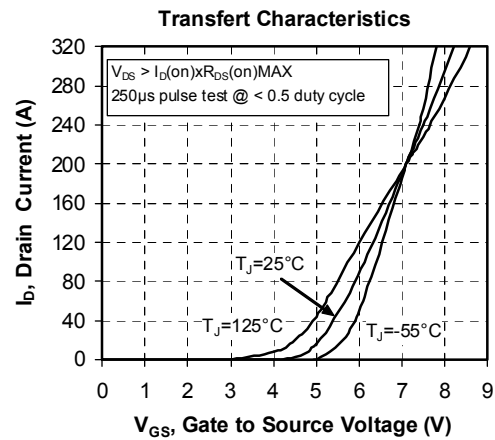
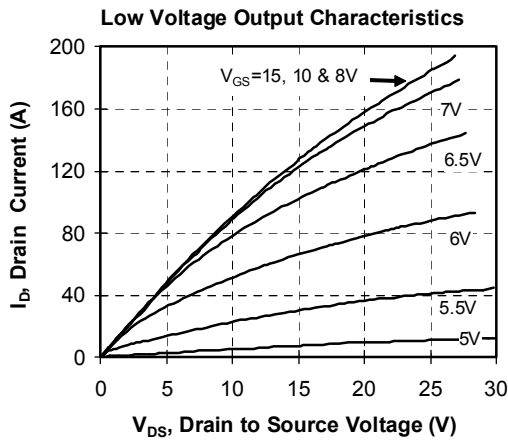
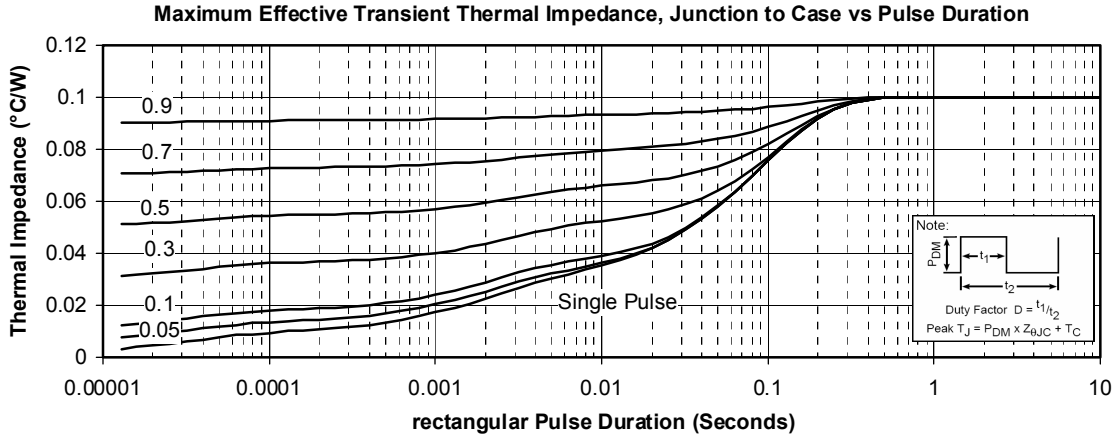
Typical Performance Curve

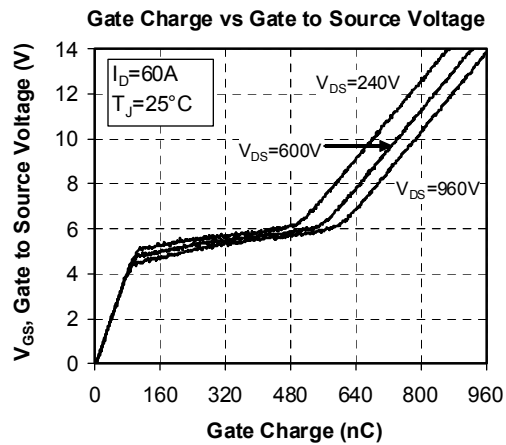
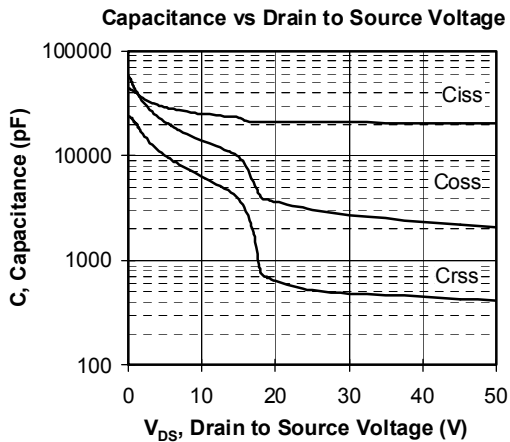
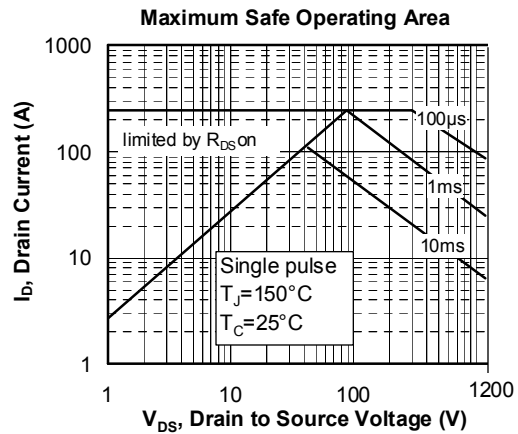
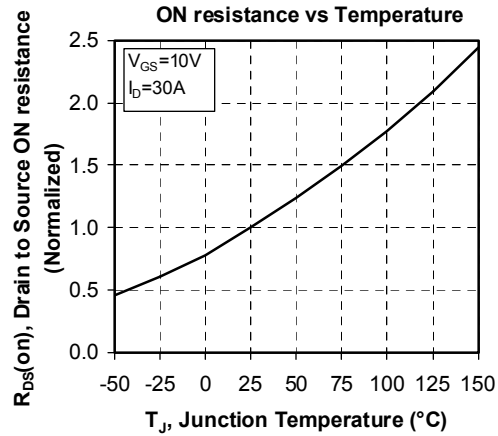

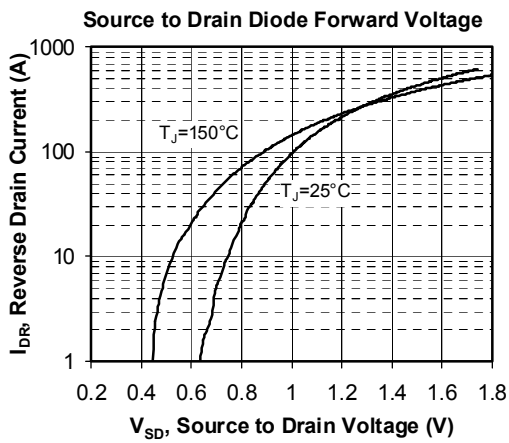
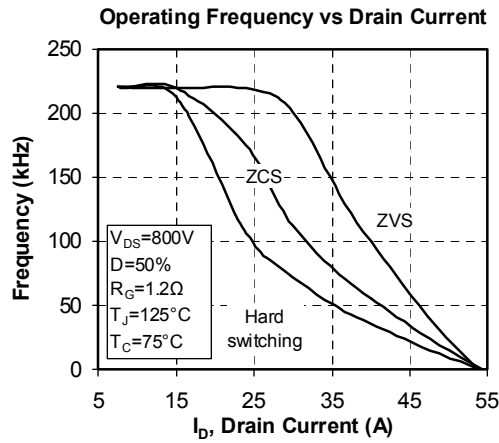
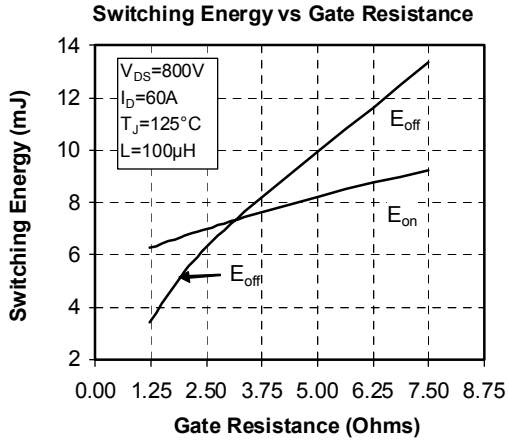
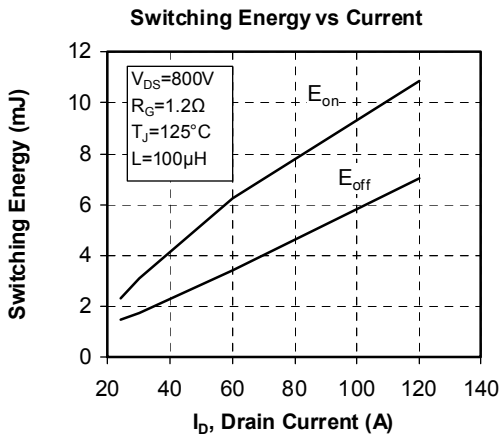
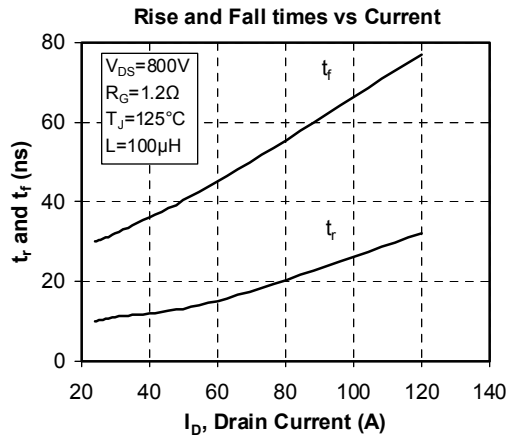
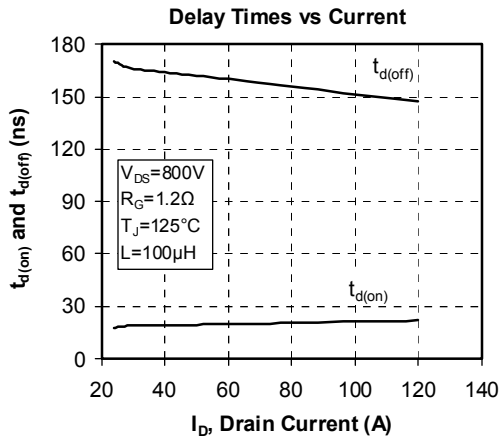

Microsemi reserves the right to change, without notice, the specifications and information contained herein

Microsemi's products are covered by one or more of U.S. patents 4,895,810 5,045,903 5,089,434 5,182,234 5,019,522 5,262,336 6,503,786 5,256,583 4,748,103 5,283,202 5,231,474 5,434,095 5,528,058 and foreign patents. U.S. and Foreign patents pending. All Rights Reserved.

